

# Installation Instructions

## Surface Fixed

Flat Pack Harmony  
Page 1 of 2



### Instrument Components:

M10 Nut



x6

M6x20 Security Screw



x3

M6 Saddle Strap

#### Metric Conversion:

178mm/ 7"  
250mm/ 10"  
400mm/ 16"  
1385mm/ 55"  
1.5m/ 59"



Weight of heaviest part 16kg (Harmony Frame)

1. Unpack frame 3no.

2. Lay packaging out on floor or assemble on non-abrasive surface to prevent marking of polished stainless steel.

3. Align holes on legs (opposite end to polished domes) and secure in place using 3no. M10 x 200mm threaded bar and 6no. M10 nuts provided  
Tools required 2no. 17mm metric spanner/wrench ( $1\frac{11}{16}$  inch or alternatively using adjustable wrench)

4. Invert assembled frame so domed ends face upwards.

5. Insert M8x60mm Security screws into pre drilled holes in frame using TX40 bit.

6. Attach Notes and Surface Plate to Harmony Frame. (See Assembly Guide Sheet)

7. Locate Harmony in desired location and mark holes to fix to desired surface.

8. Fix Surface Plate to level surface using Coachscrews, Rawlbolts, chemical anchors or similar as deemed appropriate by Installer.

(It is your responsibility to ensure that the existing surface is suitable to receive the appropriate fixing)

9. Make sure all fixings are covered and secure using cover caps provided

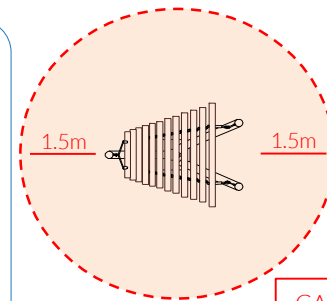

Install Instrument with 1.5m free space (from widest point) around it.

**CAUTION:**  
Harmony surface can get hot in direct sunlight, if possible install in shaded areas.

1385mm

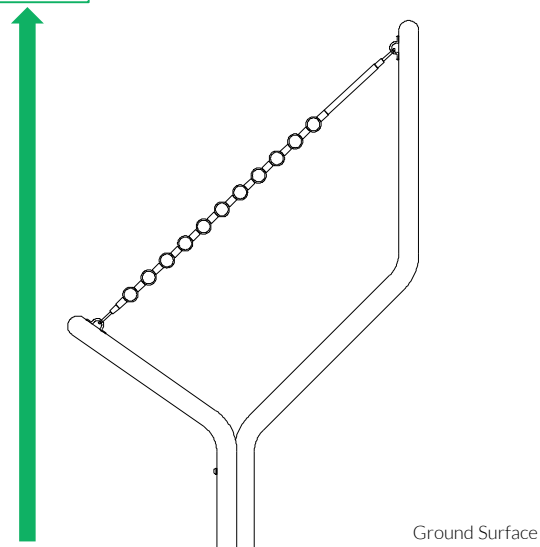

Pair Small Red Beaters X1

Surface Fix Components:



**Ground Anchors not supplied**

Spares available from [www.musical-play.com](http://www.musical-play.com) or from your local distributor

20 Kg

# Assembly Guide PPHARM

Surface Fixed  
Harmony Flat Pack  
Page 2 of 2



Instrument  
Components:

-  x6  
M6x20 Security Screw
-  x3  
M6 Saddle Strap

Thread Lock Solution  
Required

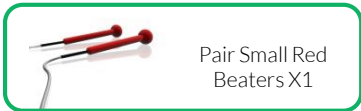

Pair Small Red  
Beaters X1

Surface Fix  
Components:

-  x2
-  x3
-  x4



Ground  
Anchors not  
supplied

Spares available from  
[www.musical-play.com](http://www.musical-play.com) or  
from your local distributor

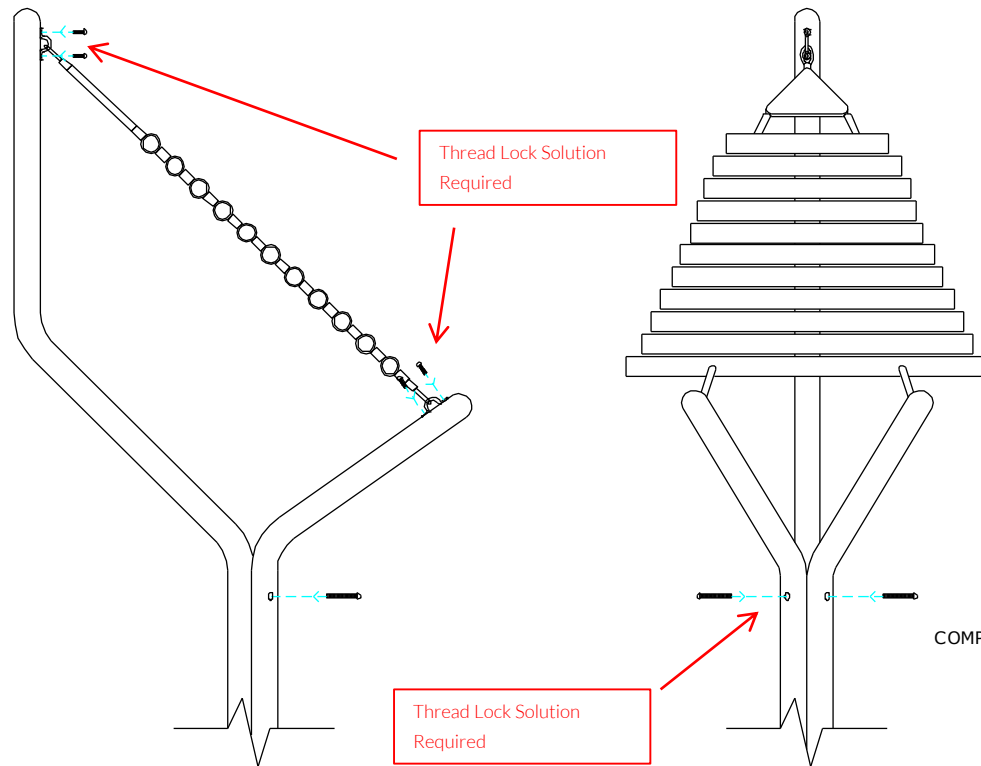
20 Kg





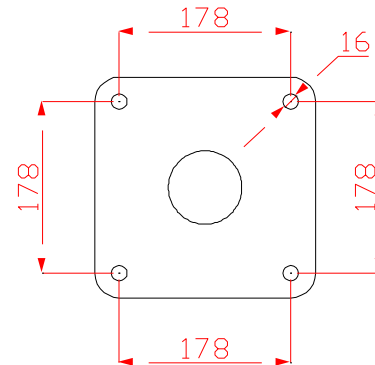

Tools:

-  x1
-  x1



COMPONENTS LIST:

-  Saddle Strap X3
-  M6x20 Pin torx X6
-  M8x60 Pin torx X2
-  M8x25 Pin torx X3
-  2 Part Cover Cap X8

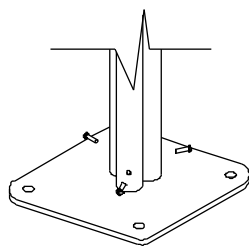

Locate the Surface fix  
Plate into the leg of the  
instrument.

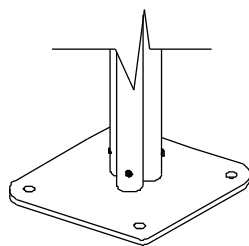

Fix instrument to Surface  
fix plate using M8x25  
Screws and use **thread  
locking solution** to  
prevent fixings working  
loose.

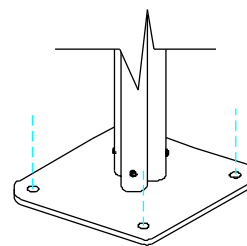

Fix Surface Plate to the  
ground surface **Ground  
Anchors Not provided**  
cover fixings with caps  
provided

**CAUTION:**  
Harmony surface  
can get hot in  
direct sunlight, if  
possible install in  
shaded areas.